

Mounting instructions for fitting kit 213073

Thank you for purchasing this Moto-Master performance product. Please read these instructions carefully before attempting installation. *

Step 1

Jack up the motorcycle and remove the front wheel. Place the wheel on a suitable work surface. Remove the installed discs and the ABS-ring (if required) by removing the disc mounting bolts (1) crosswise.

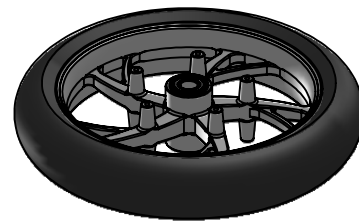

Step 2

Inspect/clean the disc contact surface of the wheel carefully. (Any remains of dirt, paint or bolt adhesive in between the disc and the wheel causes an unevenness which may lead to brake judder and accelerated disc/pad wear).
Inspect/clean the disc mounting bolts (1) and replace when damaged.

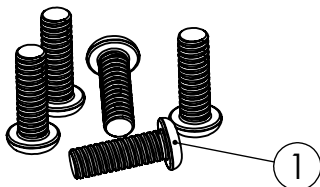

Step 3

Place the ABS-ring (2) (if required) in the original position on the left side of the wheel (3). Place the shims (4) on the ABS-ring (2). (if no ABS-ring is required place the shims (4) on the hub (3))
Place the left Moto-Master brake disc (5) with product marking visible** on the shims (4).
Place the flat washers (6) on the bolt holes of the brake disc (5).
Place the spring washers (7) on the flat washers (6). Place the floaters (8) into the spring washers (7) and flat washers (6) so they are located in the bolt holes of the brake disc (5).
Check for correct centering of the disc (5) and tighten the original bolts (1) in crosswise order with torque amount according to the bike service manual specifications.
If the manufacturer recommends the use of bolt adhesive, apply sparingly.
Carefully avoid any bolt adhesive to run in between disc and wheel contact area.
Make sure the new brake discs are free of grease, oil, silicone or any other chemicals.

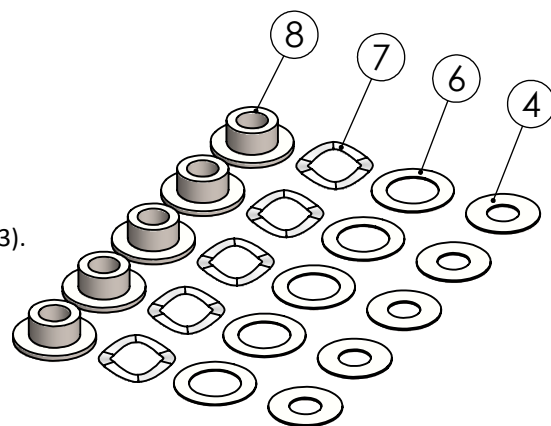

**When a direction of rotation is marked on the disc, make sure to match the direction with the direction of rotation of the wheel.

Step 4

Repeat step 3 on the right side of the wheel without installing an ABS-ring. Make sure there is no force exerted to the already installed disc to avoid any damage or warp.

Step 5

Inspect and clean the brake caliper(s) and install new brake pads. If needed, also replace the brake fluid. Reinstall the wheel on the bike***. Make sure the disc is positioned in between both brake pads.

Check for correct disc- and brake caliper alignment and torque all bolts according to the bike service manual specifications.

***Make sure the direction of rotation of the wheel and the brake discs is correct!

Step 6

Suspend the wheel from the ground so it can run freely. Operate the brake lever to engage the brake pads on to the disc(s). Check for correct engaging and pressure point of the brake. After releasing the brake the wheel should again rotate freely.

Step 7

Note: New brake pads and discs need bedding in. Brake performance can be severely reduced during this period. Avoid continuous or harsh brake actions during the first 200 km / 125 miles. Repeated hard braking during the bedding in period can result in gripping, brake loss and damaged brake pads.

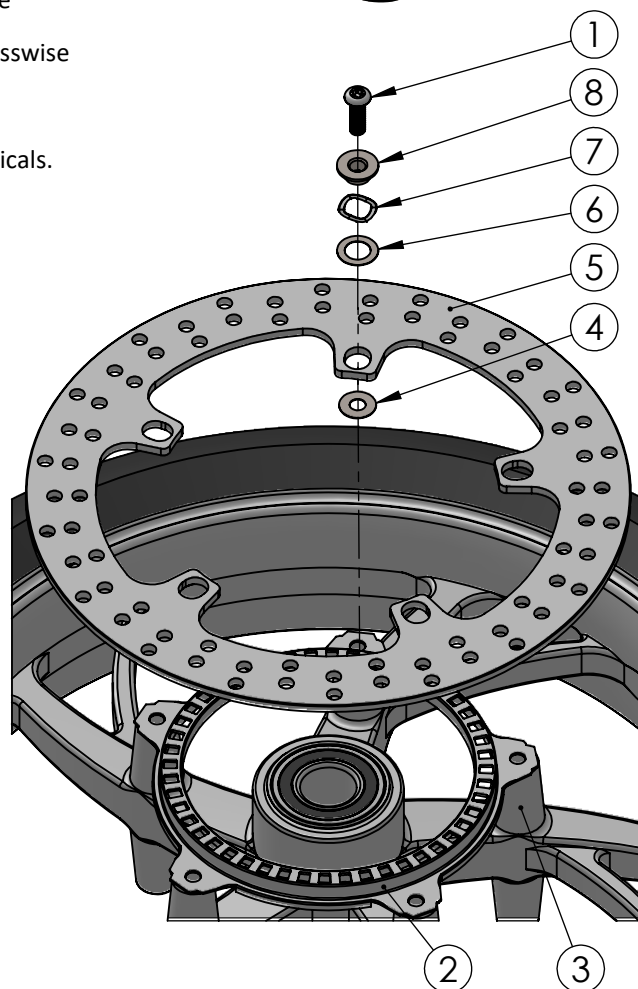

For more info, check:

WWW.MOTO-MASTER.COM

*Consult a certified dealer or professional mechanic if you are not fully qualified in motorcycle maintenance. Moto-Master cannot be held responsible for any damage or injury caused by incorrect product mounting, disregarding specifications and these instructions, or product mounting by an unqualified third party.